

# SPECIFICATION FOR LCD MODULE

**MODULE NO.: BC-0801B-SAGA-I-B-A00**  
**Doc.Version: 00**

Filled in by customer:

Check list item:

- 1.Viewing area:
- 2.Module dimension:
- 3.Module thickness:
- 4.Appearance:
- 5.Viewing angle:
- 6.Background color:
- 7.Backlight brightness:
- 8.Backlight color:
- 9.Backlight electronic characteristic
- 10.Pattern:
- 11.Contrast:
- 12.Function:
- 13.Characteristic:
- 14.Vlcd:
- 15.Module operation current:
- 16.Reliability Test:
- 17.Test Result:
- 18.Others

- |                          |    |                          |    |
|--------------------------|----|--------------------------|----|
| <input type="checkbox"/> | OK | <input type="checkbox"/> | NG |
| <input type="checkbox"/> | OK | <input type="checkbox"/> | NG |
| <input type="checkbox"/> | OK | <input type="checkbox"/> | NG |
| <input type="checkbox"/> | OK | <input type="checkbox"/> | NG |
| <input type="checkbox"/> | OK | <input type="checkbox"/> | NG |
| <input type="checkbox"/> | OK | <input type="checkbox"/> | NG |
| <input type="checkbox"/> | OK | <input type="checkbox"/> | NG |
| <input type="checkbox"/> | OK | <input type="checkbox"/> | NG |
| <input type="checkbox"/> | OK | <input type="checkbox"/> | NG |
| <input type="checkbox"/> | OK | <input type="checkbox"/> | NG |
| <input type="checkbox"/> | OK | <input type="checkbox"/> | NG |
| <input type="checkbox"/> | OK | <input type="checkbox"/> | NG |
| <input type="checkbox"/> | OK | <input type="checkbox"/> | NG |
| <input type="checkbox"/> | OK | <input type="checkbox"/> | NG |
| <input type="checkbox"/> | OK | <input type="checkbox"/> | NG |
| <input type="checkbox"/> | OK | <input type="checkbox"/> | NG |
| <input type="checkbox"/> | OK | <input type="checkbox"/> | NG |

Customer Approval:

<input type="checkbox"/> Accept	<input type="checkbox"/> Reject
---------------------------------	---------------------------------

Prepare	Engineer		
Check	Mechanical Engineer		
Check	Electronic Engineer		
Verify			
Approval			

**DOCUMENT REVISION HISTORY**

<b>Sample Version</b>	<b>Doc. Version</b>	<b>DATE</b>	<b>DESCRIPTION</b>	<b>CHANGED BY</b>
A00	00	2005-07-18	First issue	

## **CONTENTS**

<b>1.Functions &amp; Features</b>	<b>1</b>
<b>2.Mechanical Specifications</b>	<b>1</b>
<b>3.Block Diagram</b>	<b>1</b>
<b>4,Dimensional Outline</b>	<b>2</b>
<b>5.Power Supply</b>	<b>3</b>
<b>6.Pin Description</b>	<b>3</b>
<b>7.Maximum Absolute Limit</b>	<b>4</b>
<b>8.Electrical Characteristics</b>	<b>4</b>
<b>9.Control and Display Command</b>	<b>6</b>
<b>10.Standard Character Pattern</b>	<b>7</b>
<b>11.Relationship between DDRAM and CGRAM</b>	<b>8</b>
<b>12.Initializing by Instruction</b>	<b>9</b>
<b>13.Package Specifications</b>	<b>11</b>
<b>14.Quality Specifications</b>	<b>12</b>
<b>15.Describe to the Part No.</b>	<b>19</b>

## 1.FUNCTIONS & FEATURES

- |   |   |
|---|---|
| 1-1. Format                                   | : 8characters*1 lines 5*8 dots format                           |
| 1-2. LCD mode                                 | : STN/Gray/Positive/Reflective                                  |
| 1-3. Viewing direction                        | : 6 o'clock   |
| 1-4. Driving scheme                           | : 1/8 duty, 1/4 bias, V <sub>LCD</sub> 4.5V                     |
| 1-5. Internal Memory                          | : CGROM (10080bits)<br>: CGRAM (64*8bits)<br>: DDRAM (80*8bits) |
| 1-6. Easy interface with a 8-bit MPU/4-bitMPU |   |

## 2.MECHANICAL SPECIFICATIONS

- |                   |                         |
|-------------------|-------------------------|
| 2-1. Module size  | : 84(W)*44(H)*10MAX (T) |
| 2-2. Viewing area | : 61( W)* 15.8(H)       |
| 2-3. Dot pitch    | : 1.3(W)*1.35(H)        |
| 2-4. Dot size     | : 1.25(W) *1.3(H)       |

## 3.BLOCK DIAGRAM

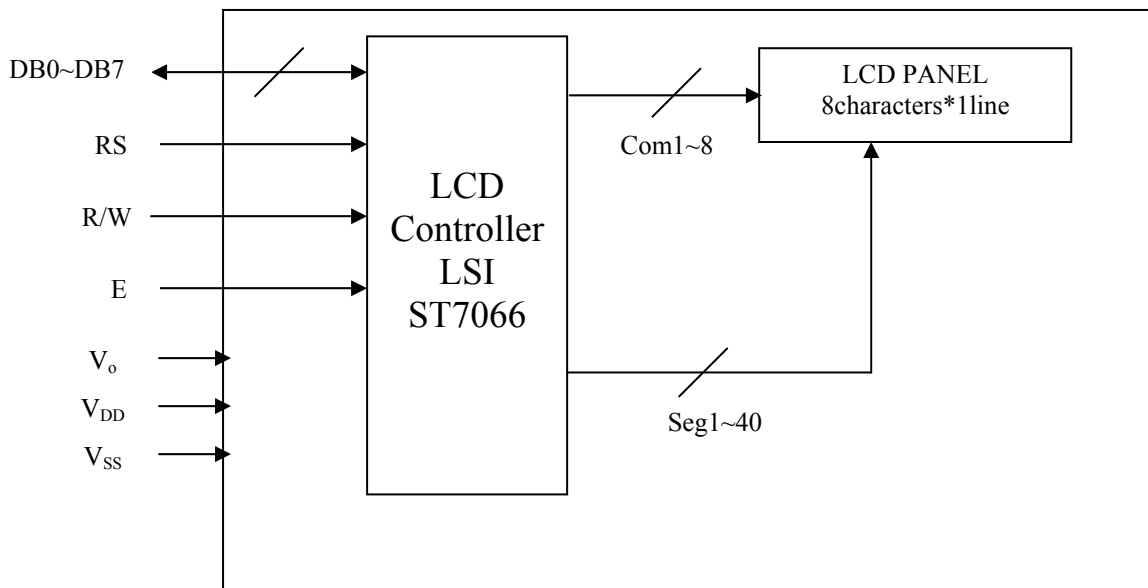

## 4.DIMENSIONAL OUTLINE

Part drawing & Specification record during discussion with vendor

Rec. #1	FIRST ISSUE	Revision content description	Date
			2005-07-18

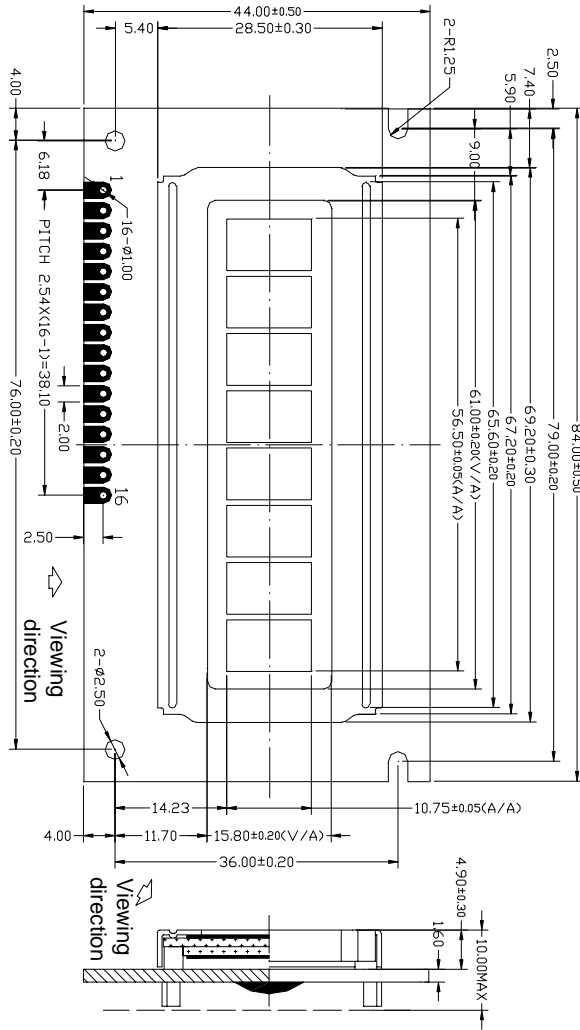

PIN	1	2	3	4	5	6	7	8	9	10	11	12	13	14	15	16
NAME	VSS	VDD	V0	RS	R/W	E	DB0	DB1	DB2	DB3	DB4	DB5	DB6	DB7	LED+	LED-

**Specification:**

- 1) Display mode: STN/Gray/Positive/Reflective
- 2) Driving condition: 1/8 Duty, 1/4 Bias, VLCD: 4.5V
- 3) Viewing angle: 6 O'clock
- 4) Operating temp.: 0~50°C  
Storage temp.: -20~70°C
- 5) Unspecified tolerance is ±0.3mm
- 6) Rohs Request

	UNIT	SIZE	SCALE	MOD. No. <b>BC-0801B-SAGA-N-B</b> -A	DESIGNED	CHECKED	VERIFIED	APPROVED	MATERIAL	WEIGHT
	mm	A4	FIT						NUMBER	TOTAL
									FILE NAME	<b>Count Dwg.</b>

## 5. POWER SUPPLY

### LCD MODULE

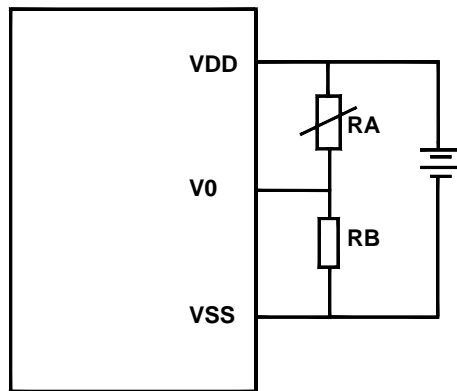

$V_{DD}-V_0$ =Operating voltage for LCD

## 6. PIN DESCRIPTION

Pin no.	Symbol	Function
1	$V_{SS}$	Ground
2	$V_{DD}$	Supply voltage for logic circuit
3	V0	Voltage level for LCD driving
4	RS	Selects register data "H" and instruction "L"
5	R/W	Use as read/write select input
6	E	Use as read/write enable signal
7	DB0	Display data signal
8	DB1	
9	DB2	
10	DB3	
11	DB4	
12	DB5	
13	DB6	
14	DB7	
15	LED+	NC
16	LED-	NC

## 7. MAXIMUM ABSOLUTE LIMIT (T=25°C)

Item	Symbol	Standard value	Unit
Power supply voltage for logic	V <sub>DD</sub>	-0.3~+7.0	V
Driver supply voltage for LCD (V <sub>DD</sub> -V <sub>0</sub> )	V <sub>LCD</sub>	V <sub>DD</sub> -10.0~V <sub>DD</sub> +0.3	V
Operating temperature	Topr	-0~+50	°C
Storage temperature	Tstg	-20~+70	°C

Note: Voltage greater than above may damage the module

## 8. ELECTRICAL CHARACTERISTICS

### 8-1 DC Characteristics (V<sub>DD</sub>=4.5~5.5V, Ta=-0~+50°C)

Item	Symbol	Min	Typ	Max	Unit	Test condition
Operating voltage	V <sub>DD</sub>	4.5	5	5.5	V	-
Supply current	I <sub>DD</sub>			3	mA	f <sub>OSC</sub> =270kHz
Input voltage	V <sub>IL</sub>	-0.3	-	0.6	V	-
	V <sub>IH</sub>	0.7 V <sub>DD</sub>	-	V <sub>DD</sub>	V	-
Output voltage	V <sub>OL</sub>	-	-	0.4	V	I <sub>OL</sub> =-0.1mA
	V <sub>OH</sub>	3.9	-	V <sub>DD</sub>	V	I <sub>OH</sub> =0.1mA
Input leakage current	I <sub>IKG</sub>	-1	-	1	μA	V <sub>IN</sub> =0 to V <sub>DD</sub>
LCD driving voltage	V <sub>LCD</sub>	4.3	4.5	4.8	V	Ta=25°C

### 8-2 AC Characteristics (V<sub>DD</sub>=4.5~5.5V, Ta=0~+50°C)

#### 8-2-1. Write mode (Writing data from MPU to LCD MODULE)

T <sub>C</sub>	Enable Cycle Time	Pin E	1200	-	-	ns
T <sub>PW</sub>	Enable Pulse Width	Pin E	140	-	-	ns
T <sub>R,Tf</sub>	Enable Rise/Fall Time	Pin E	-	-	25	ns
T <sub>AS</sub>	Address Setup Time	Pins: RS,RW,E	0	-	-	ns
T <sub>AH</sub>	Address Hold Time	Pins: RS,RW,E	10	-	-	ns
T <sub>DSW</sub>	Data Setup Time	Pins: DB0 - DB7	40	-	-	ns
T <sub>H</sub>	Data Hold Time	Pins: DB0 - DB7	10	-	-	ns

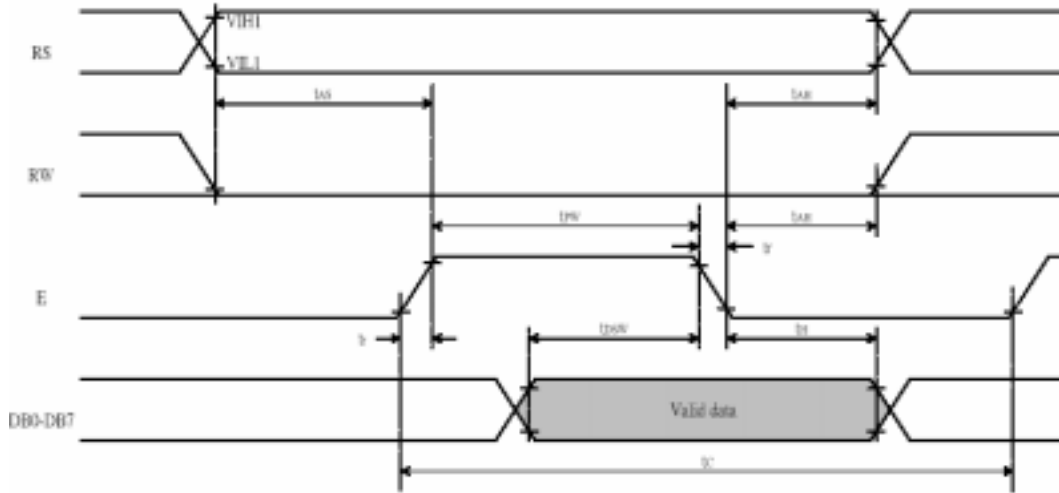

**8-2-2. Read mode (Reading data from LCD MODULE to MPU)**

$T_C$	Enable Cycle Time	Pin E	1200	-	-	ns
$T_{PW}$	Enable Pulse Width	Pin E	140	-	-	ns
$T_{R,TF}$	Enable Rise/Fall Time	Pin E	-	-	25	ns
$T_{AS}$	Address Setup Time	Pins: RS,RW,E	0	-	-	ns
$T_{AH}$	Address Hold Time	Pins: RS,RW,E	10	-	-	ns
$T_{DDR}$	Data Setup Time	Pins: DB0 - DB7	-	-	100	ns
$T_H$	Data Hold Time	Pins: DB0 - DB7	10	-	-	ns

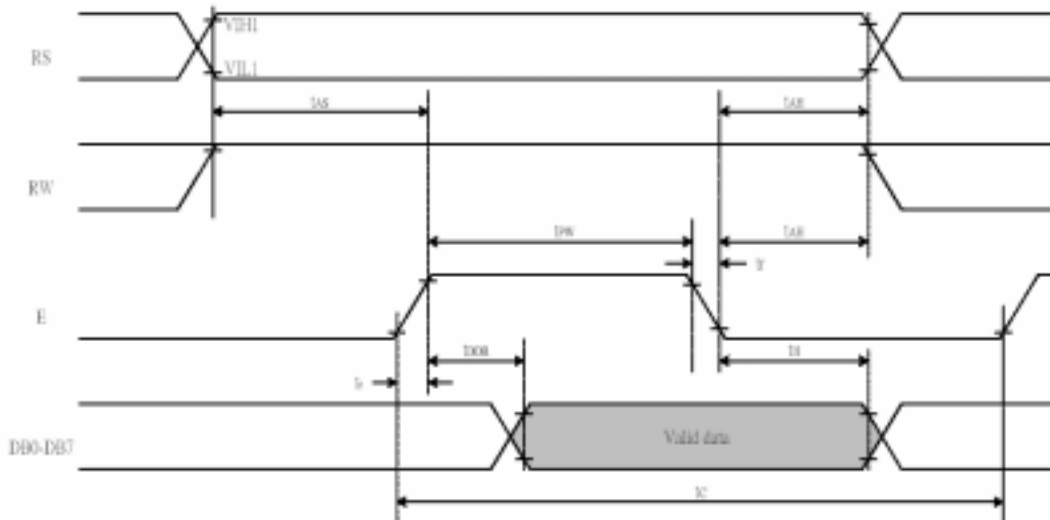

## 9.CONTROL AND DISPLAY COMMAND

Instruction	Instruction Code										Description	Description Time (270KHz)	
	RS	R/W	DB7	DB6	DB5	DB4	DB3	DB2	DB1	DB0			
Clear Display	0	0	0	0	0	0	0	0	0	1	Write "20H" to DDRAM, and set DDRAM address to "00H" from AC	1.52 ms	
Return Home	0	0	0	0	0	0	0	0	0	1	Set DDRAM address to "00H" from AC and return cursor to its original position if shifted. The contents of DDRAM are not changed.	1.52 ms	
Entry Mode Set	0	0	0	0	0	0	0	0	1	I/D	S	Sets cursor move direction and specifies display shift. These operations are performed during data write and read.	37 us
Display ON/OFF	0	0	0	0	0	0	0	1	D	C	B	D=1:entire display on C=1:cursor on B=1:cursor position on	37 us
Cursor or Display Shift	0	0	0	0	0	0	1	S/C	R/L	x	x	Set cursor moving and display shift control bit, and the direction, without changing DDRAM data.	37 us
Function Set	0	0	0	0	0	1	DL	N	F	x	x	DL:interface data is 8/4 bits N:number of line is 2/1 F:font size is 5x11/5x8	37 us
Set CGRAM address	0	0	0	1	AC5	AC4	AC3	AC2	AC1	AC0	Set CGRAM address in address counter	37 us	
Set DDRAM address	0	0	1	AC6	AC5	AC4	AC3	AC2	AC1	AC0	Set DDRAM address in address counter	37 us	
Read Busy flag and address	0	1	BF	AC6	AC5	AC4	AC3	AC2	AC1	AC0	Whether during internal operation or not can be known by reading BF. The contents of address counter can also be read.	0 us	
Write data to RAM	1	0	D7	D6	D5	D4	D3	D2	D1	D0	Write data into internal RAM (DDRAM/CGRAM)	37 us	
Read data from RAM	1	1	D7	D6	D5	D4	D3	D2	D1	D0	Read data from internal RAM (DDRAM/CGRAM)	37 us	

**Note:**

Be sure the ST7066U is not in the busy state (BF = 0) before sending an instruction from the MPU to the ST7066U. If an instruction is sent without checking the busy flag, the time between the first instruction and next instruction will take much longer than the instruction time itself. Refer to Instruction Table for the list of each instruction execution time.

## 10.STANDARD CHARACTER PATTERN

Upper 4bits / Lower 4bit	LLLL	LLLH	LLHL	LLHH	LHLL	LHLH	LHHL	LHHH	HLLL	HLLH	HLHL	HLHH	HHLL	HHLH	HHHL	HHHH
LLLL (CG RAM (1))																
LLLH (2)																
LLHL (3)																
LLHH (4)																
LHLL (5)																
LHLH (6)																
LHHL (7)																
LHHH (8)																
HLLL (1)																
HLLH (2)																
HLHL (3)																
HLHH (4)																
HHLL (5)																
HHLH (6)																
HHHL (7)																
HHHH (8)																

## 11.RELATIONSHIP BETWEEN DDRAM AND CGRAM

Character code (DDRAM data)								CGRAM address					CGRAM data								Pattern	
D7	D6	D5	D4	D3	D2	D1	D0	A5	A4	A3	A2	A1	A0	P7	P6	P5	P4	P3	P2	P1	P0	Number
0	0	0	0	x	0	0	0	0	0	0	0	0	0	x	x	x	1	0	0	0	1	Pattern1
				.						0	0	1		.			1	0	0	0	1	
				.						0	1	0		.			1	0	0	0	1	
				.						0	1	1		.		0	1	0	1	0		
				.						1	0	0		.		0	0	1	0	0		
				.						1	0	1		.		0	0	1	0	0		
				.						1	1	0		.		0	0	1	0	0		
				.						1	1	1		.		0	0	0	0	0		
0	0	0	0	x	1	1	1	1	1	1	0	0	0	x	x	x	1	1	1	1	0	Pattern8
				.						0	0	1		.			1	0	0	0	1	
				.						0	1	0		.			1	0	0	0	1	
				.						0	1	1		.		1	1	1	1	0		
				.						1	0	0		.		1	0	0	0	1		
				.						1	0	1		.		1	0	0	0	1		
				.						1	1	0		.		1	1	1	1	0		
				.						1	1	1		.		0	0	0	0	0		

CGRAM has up to 5\*8 dots 8 characters.

By writing font data to CGRAM, user defined characters can be used

## 12. INITIALIZING BY INSTRUCTION

8-bit interface (fosc=270KHz)

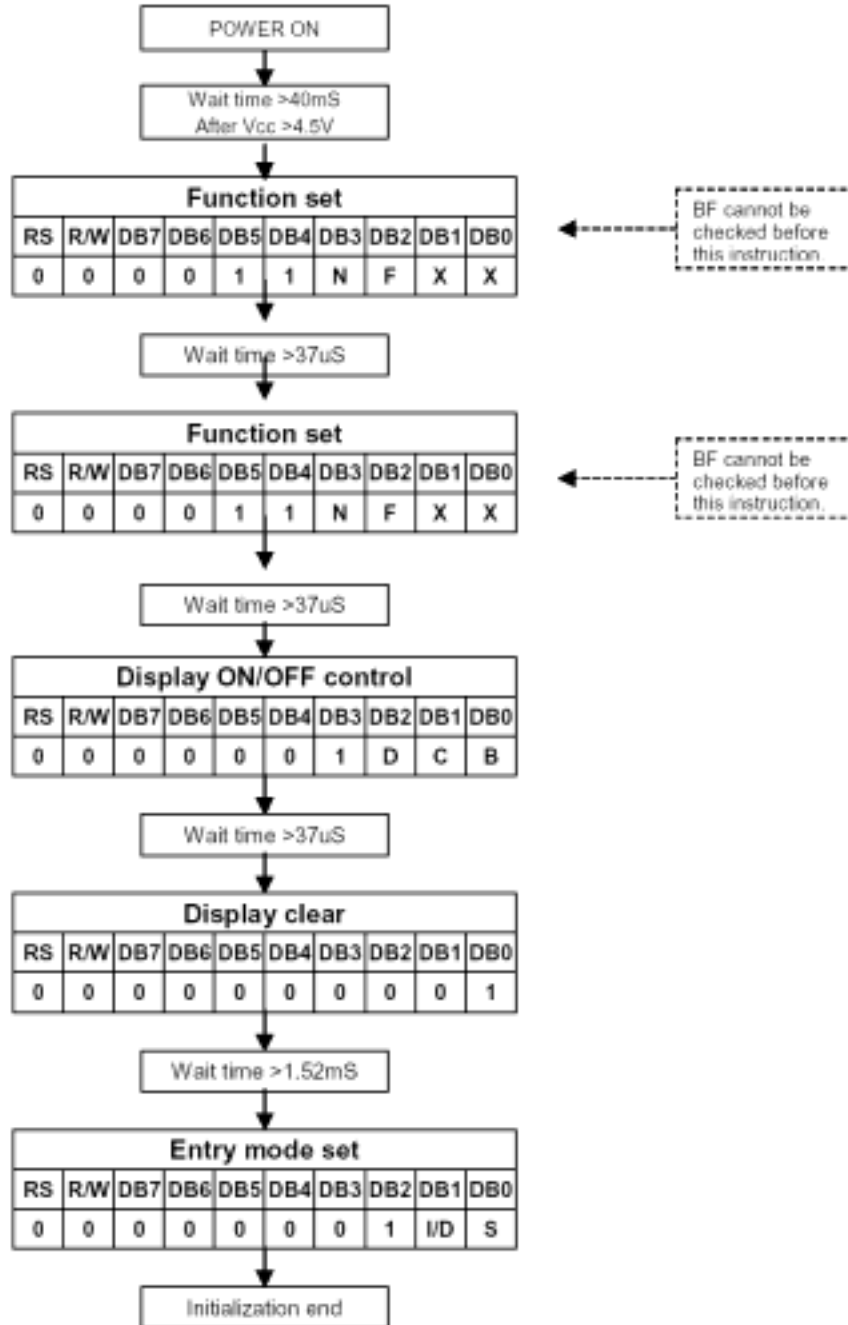

4-bit Interface (fosc=270KHz)

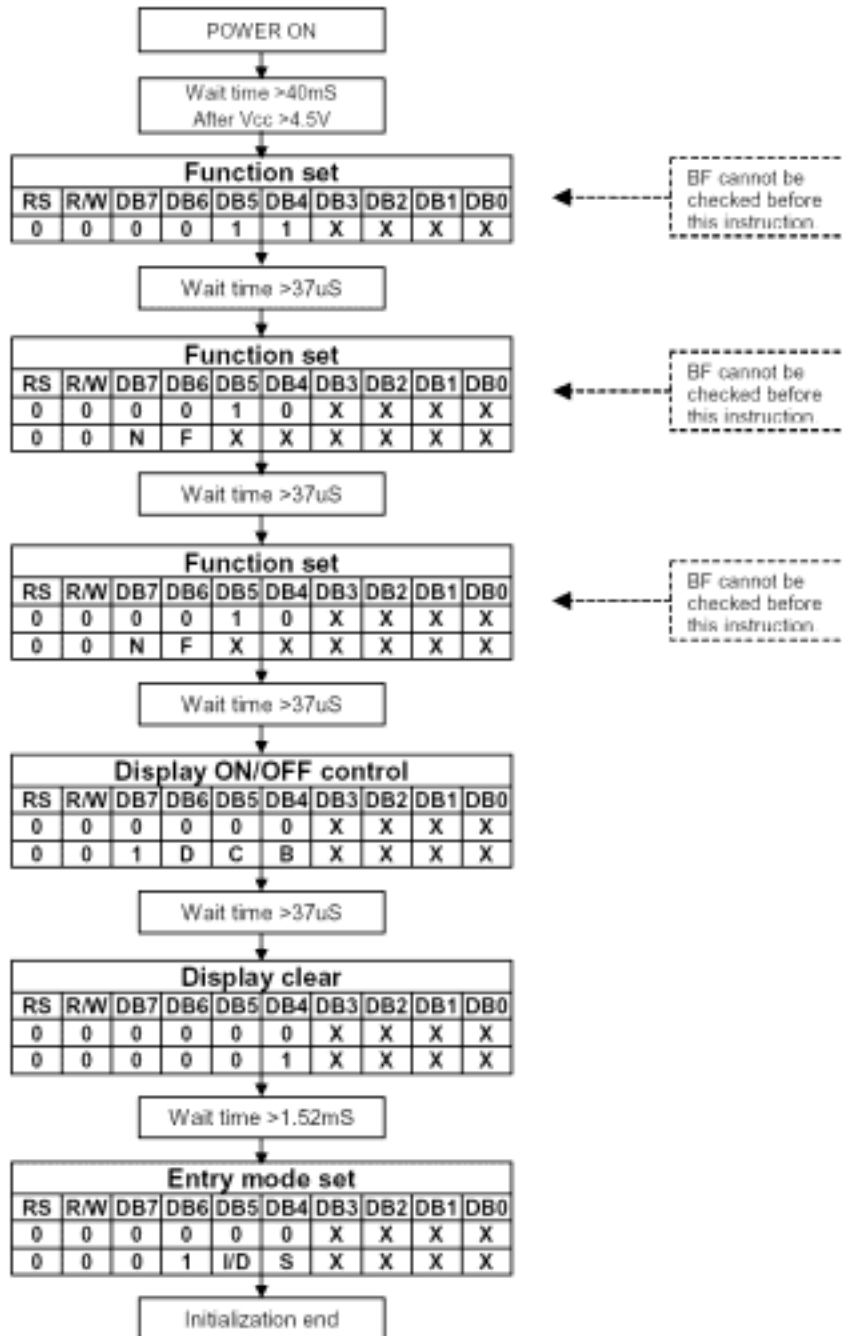

### 13.PACKAGE SPECIFICATIONS

	REV 00	DESCRIPTION FIRST ISSUE	DATE 2005-03-30
--	-----------	----------------------------	--------------------

  

	UNIT mm	SIZE A4	SCALE FIT	
--	------------	------------	--------------	--

	PART NO. DESIGNED	BC-0801B-PK-N-B -A CHECKED	VERIFIED	MATERIAL NUMBER APPROVED	WEIGHT TOTAL	FILE NAME PACKAGE
--	----------------------	----------------------------------	----------	-----------------------------	--------------	----------------------

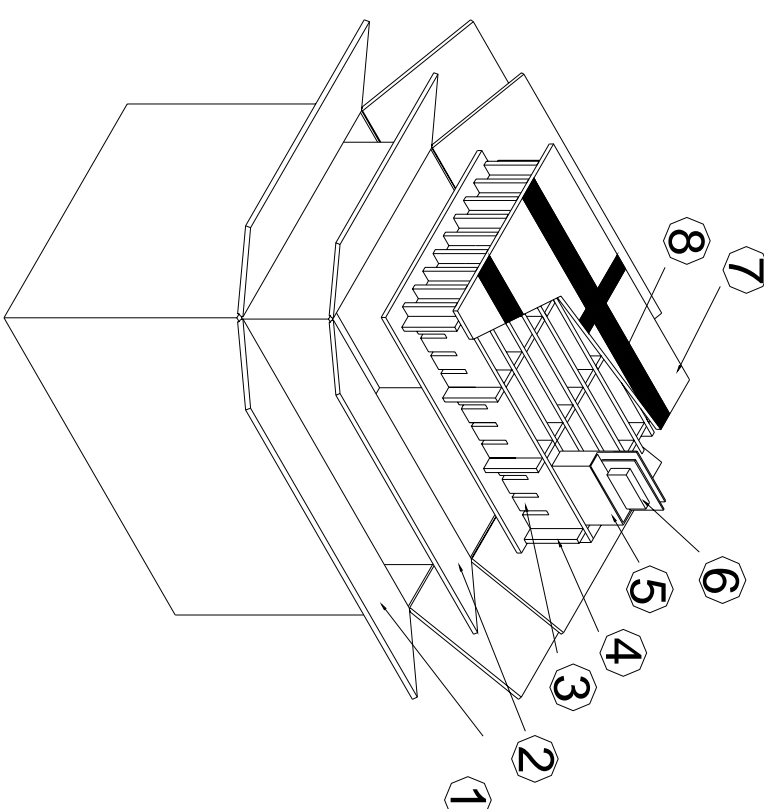

name	unit	qty per	spec	material	remark
1 carton	pcs	1	400*300*285	paper	"A" type
2 Sub-carton	pcs	1	375*270*260	paper	"A" type
3 long separator	pcs	36	360*50	paper	"B" type
4 short separator	pcs	16	255*50	paper	"B" type
5 bubble	pcs	96	100*100*50	PE	"D" type
6 module	pcs	96	84*44*10		be careful in put
7 stiff board	pcs	5	360*285	paper	"A" type
8 Adhesive tape	m	3	1.0	PE	"A" SHAPE

**Specification:**

One carton contains 4 layers, 24 modules put in each layer. Each bottom and top side a reinforcement board is added. then using adhesive tape for enlacing.

One carton can contain 24X4=96 modules.

## 14. Quality Specifications

### 14-1. Electro-Optic Characteristics

NO	ITEM		Symbol	Temp	Rating			Unit
					Min	Typ	Max	
1	Response	Rise time	Tr	25		200		Ms
	time	Fall time	Tf			240		
2	Operating Frequency		Ff	25		64		Hz
3	Contrast Rate		Cr	25		9		
4	Viewing Direction		6 0 ' CLOCK					
5	Viewing Angle	12H =90 °	1	25		30		Deg
		6H =270 °	2			60		
		3H =0 °	3			30		
		9H =180 °	4			30		
6	Current consumption		Is	25		7.6	11.4	uA
7	Capacitance		C	25		2.7		nF

#### Response Time

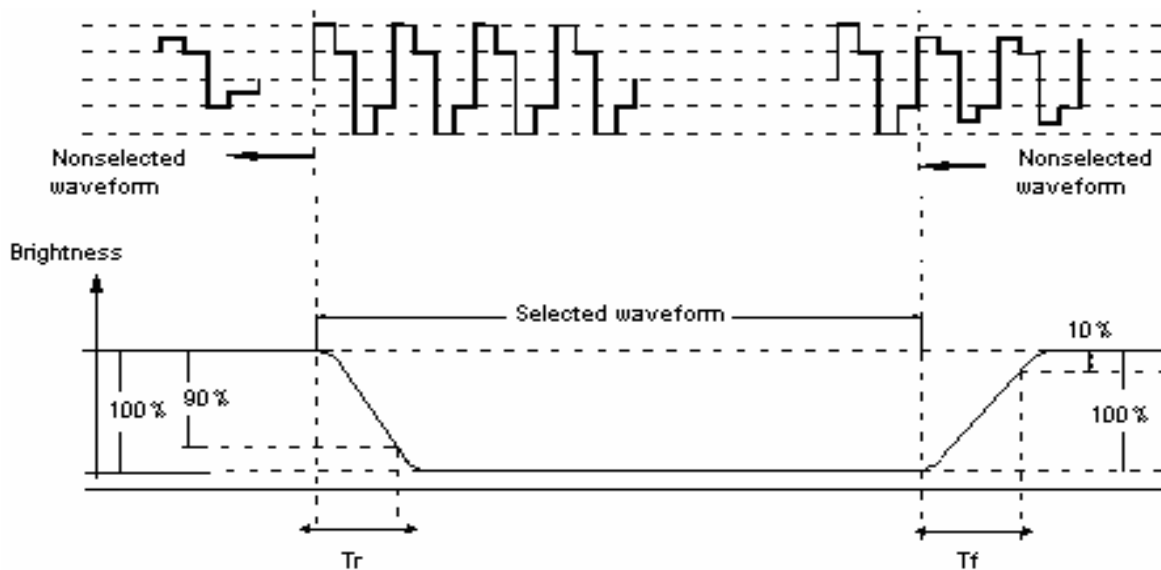

#### Measuring Condition:

1. Driving waveform: 1/N Duty, 1/a Bias selected waveform.
2. Driving Frequency: Typical value in Individual specification.
3. Operating Voltage: LCD driving voltage getting maximum contrast rate.
4. Measuring Angle: See Individual Specification.
5. Measuring Temperature: See Individual Specification .

## Contrast Ratio Definition

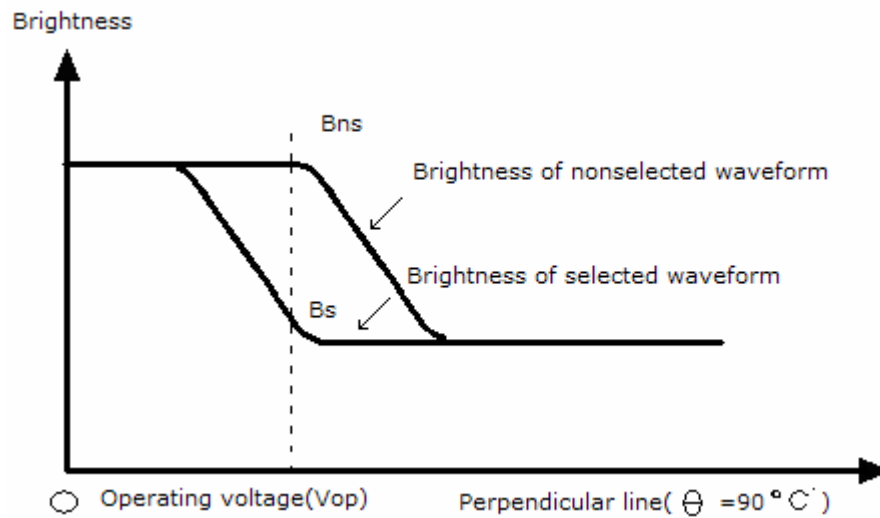

### 1. Positive Type

$$\text{Contrast Ratio (Cr)} = \frac{\text{Brightness of non-selected waveform (Bns)}}{\text{Brightness of selected waveform (Bs)}}$$

### Viewing Angle

$\theta$ : Angle between Viewer Direction and Normal.

( $-90^\circ$   $90^\circ$ )

$\phi$ : Angle between Projection of Viewer Direction to X-Y plane and Y axis.

( $0^\circ$   $\phi$   $360^\circ$ )

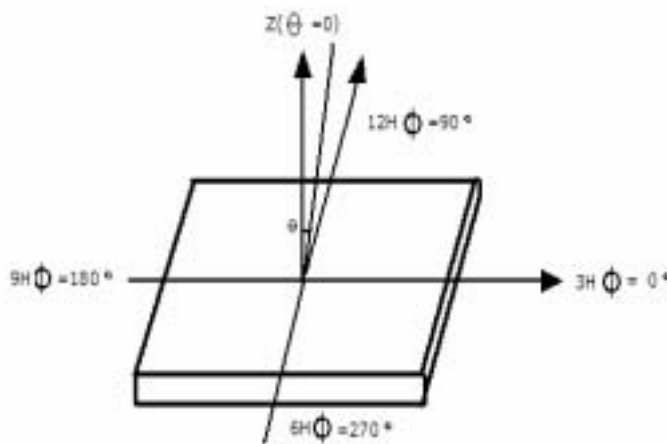

### Measuring Condition

1. Driving Voltage: Same as Vop.
2. Driving Frequency: Same as Frame Frequency

## 14-2. Specification of quality assurance

AQL inspection standard

Sampling method: MIL-STD-105E, Level II, single sampling

### Defect classification

Classify	Item		Note	AQL	
Major	Display	Short or open circuit	1	0.65	
		State			Contrast defect (dim, ghost)
		LC leakage			
		Flickering			
		No display			
		Wrong viewing direction	2		
		Wrong Back-light	7		
	Non-display	Flat cable or pin reverse	9		
Wrong or missing component		10			
Minor	Display	Background color deviation	2	1.5	
		State	Black spot and dust		3
		Line defect	4		
		Scratch			
		Rainbow	5		
		Pin hole	6		
	Polarizer	Bubble and foreign material	3		
		Scratch	4		
	PCB	Scratch	4		
	Soldering	Poor connection	8		
	Wire	Poor connection	9		

### Note on defect classification

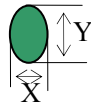
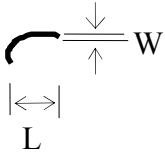
No.	Item	Criterion																				
1	Short or open circuit	Not allow																				
	LC leakage																					
	Flickering																					
	No display																					
	Wrong viewing direction																					
	Wrong Back-light																					
2	Contrast defect	Refer to approval sample																				
	Background color deviation																					
3	Point defect, Black spot, dust (incl. Polarizer)  $\phi = (X+Y)/2$	 <table border="1" data-bbox="940 911 1378 1209"> <thead> <tr> <th colspan="2">Point Size</th> <th>Acceptable Qty.</th> </tr> </thead> <tbody> <tr> <td colspan="2"><math>\phi \leq 0.10</math></td> <td>Disregard</td> </tr> <tr> <td><math>0.10 &lt; \phi</math></td> <td>0.20</td> <td>3</td> </tr> <tr> <td><math>0.20 &lt; \phi</math></td> <td>0.25</td> <td>2</td> </tr> <tr> <td><math>0.25 &lt; \phi</math></td> <td>0.30</td> <td>1</td> </tr> <tr> <td colspan="2"><math>\phi &gt; 0.30</math></td> <td>0</td> </tr> </tbody> </table> <p style="text-align: right;">Unit : mm</p>	Point Size		Acceptable Qty.	$\phi \leq 0.10$		Disregard	$0.10 < \phi$	0.20	3	$0.20 < \phi$	0.25	2	$0.25 < \phi$	0.30	1	$\phi > 0.30$		0		
Point Size		Acceptable Qty.																				
$\phi \leq 0.10$		Disregard																				
$0.10 < \phi$	0.20	3																				
$0.20 < \phi$	0.25	2																				
$0.25 < \phi$	0.30	1																				
$\phi > 0.30$		0																				
4	Line defect	 <table border="1" data-bbox="869 1391 1422 1650"> <thead> <tr> <th colspan="2">Line</th> <th>Acceptable Qty.</th> </tr> <tr> <th>L</th> <th>W</th> <th></th> </tr> </thead> <tbody> <tr> <td>---</td> <td>0.015 W</td> <td>Disregard</td> </tr> <tr> <td>3.0 L</td> <td>0.03 W</td> <td rowspan="2">2</td> </tr> <tr> <td>2.0 L</td> <td>0.05 W</td> </tr> <tr> <td>1.0 L</td> <td>0.1 &gt; W</td> <td>1</td> </tr> <tr> <td>---</td> <td>0.05 &lt; W</td> <td>Applied as point defect</td> </tr> </tbody> </table> <p style="text-align: right;">Unit: mm</p>	Line		Acceptable Qty.	L	W		---	0.015 W	Disregard	3.0 L	0.03 W	2	2.0 L	0.05 W	1.0 L	0.1 > W	1	---	0.05 < W	Applied as point defect
Line		Acceptable Qty.																				
L	W																					
---	0.015 W	Disregard																				
3.0 L	0.03 W	2																				
2.0 L	0.05 W																					
1.0 L	0.1 > W	1																				
---	0.05 < W	Applied as point defect																				
5	Rainbow	Not more than two color changes across the viewing area.																				

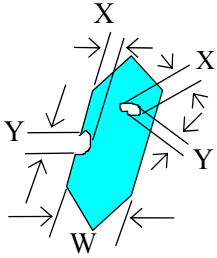
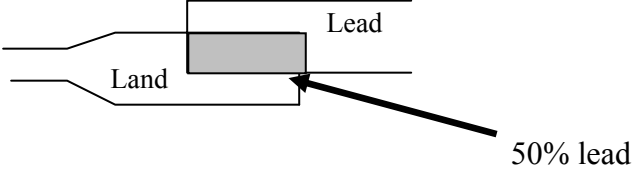
No.	Item	Criterion								
6	Segment pattern W = Segment width $\phi = (X+Y)/2$	<p>(1) Pin hole <math>\phi &lt; 0.10\text{mm}</math> is acceptable.</p>  <table border="1" data-bbox="933 526 1396 698"> <thead> <tr> <th>Point Size</th> <th>Acceptable Qty</th> </tr> </thead> <tbody> <tr> <td><math>\phi &lt; 1/4W</math></td> <td>Disregard</td> </tr> <tr> <td><math>1/4W &lt; \phi &lt; 1/2W</math></td> <td>1</td> </tr> <tr> <td><math>\phi &gt; 1/2W</math></td> <td>0</td> </tr> </tbody> </table> <p style="text-align: right;">Unit: mm</p>	Point Size	Acceptable Qty	$\phi < 1/4W$	Disregard	$1/4W < \phi < 1/2W$	1	$\phi > 1/2W$	0
Point Size	Acceptable Qty									
$\phi < 1/4W$	Disregard									
$1/4W < \phi < 1/2W$	1									
$\phi > 1/2W$	0									
7	Back-light	<p>(1) The color of backlight should correspond its specification. (2) Not allow flickering</p>								
8	Soldering	<p>(1) Not allow heavy dirty and solder ball on PCB. (The size of dirty refer to point and dust defect) (2) Over 50% of lead should be soldered on Land.</p> 								
9	Wire	<p>(1) Copper wire should not be rusted (2) Not allow crack on copper wire connection. (3) Not allow reversing the position of the flat cable. (4) Not allow exposed copper wire inside the flat cable.</p>								
10	PCB	<p>(1) Not allow screw rust or damage. (2) Not allow missing or wrong putting of component.</p>								

**14-3. Reliability of LCM**

Reliability test condition:

Item	Condition	Time (hrs)	Assessment
High temp. Storage	70°C	240	No abnormalities in functions and appearance
High temp. Operating	50°C	240	
Low temp. Storage	-20°C	240	
Low temp. Operating	0°C	240	
Humidity	40°C/ 90%RH	240	
Temp. Cycle	$-20^{\circ}\text{C} \rightarrow 25^{\circ}\text{C} \rightarrow 70^{\circ}\text{C} \rightarrow 25^{\circ}\text{C}$ (1 hour → 5 min → 1 hour → 5 min)	10cycles	

Recovery time should be 240 hours minimum. Moreover, functions, performance and appearance shall be free from remarkable deterioration within 50,000 hours under ordinary operating and storage conditions room temperature (20±8°C), normal humidity (below 65% RH), and in the area not exposed to direct sun light.

**14-4. Precaution for using LCM**

LCM is assembled and adjusted with a high degree of precision. Do not attempt to make any alteration or modification. The followings should be noted.

**General Precautions:**

1. LCD panel is made of glass. Avoid excessive mechanical shock or applying strong pressure onto the surface of display area.
2. The polarizer used on the display surface is easily scratched and damaged. Extreme care should be taken when handling. To clean dust or dirt off the display surface, wipe gently with cotton, or other soft material soaked with isopropyl alcohol, ethyl alcohol or trichloroethylene, do not use water, ketone or aromatics and never scrub hard.
3. Do not tamper in any way with the tabs on the metal frame.
4. Do not make any modification on the PCB without consulting YB.
5. When mounting a LCM, make sure that the PCB is not under any stress such as bending or twisting. Elastomer contacts are very delicate and missing pixels could result from slight dislocation of any of the elements.
6. Avoid pressing on the metal bezel, otherwise the elastomer connector could be deformed and lose contact, resulting in missing pixels and also cause rainbow on the display.
7. Be careful not to touch or swallow liquid crystal that might leak from a damaged cell. Any liquid crystal adheres to skin or clothes, wash it off immediately with soap and water.

**Static Electricity Precautions:**

1. CMOS-LSI is used for the module circuit; therefore operators should be grounded whenever he/she comes into contact with the module.
2. Do not touch any of the conductive parts such as the LSI pads; the copper leads on the PCB and the interface terminals with any parts of the human body.
3. Do not touch the connection terminals of the display with bare hand; it will cause disconnection or defective insulation of terminals.
4. The modules should be kept in anti-static bags or other containers resistant to static for storage.
5. Only properly grounded soldering irons should be used.
6. If an electric screwdriver is used, it should be grounded and shielded to prevent sparks.
7. The normal static prevention measures should be observed for work clothes and working benches.
8. Since dry air is inductive to static, a relative humidity of 50-60% is recommended.

**Soldering Precautions:**

1. Soldering should be performed only on the I/O terminals.
2. Use soldering irons with proper grounding and no leakage.
3. Soldering temperature:  $300^{\circ}\text{C} \pm 10^{\circ}\text{C}$
4. Soldering time: 3 to 4 second.
5. Use eutectic solder with resin flux filling.
6. If flux is used, the LCD surface should be protected to avoid spattering flux.
7. Flux residue should be removed.

**Operation Precautions:**

1. The viewing angle can be adjusted by varying the LCD driving voltage  $V_o$ .
2. Since applied DC voltage causes electro-chemical reactions, which deteriorate the display, the applied pulse waveform should be a symmetric waveform such that no DC component remains. Be sure to use the specified operating voltage.
3. Driving voltage should be kept within specified range; excess voltage will shorten display life.
4. Response time increases with decrease in temperature.
5. Display color may be affected at temperatures above its operational range.

**Operation Precautions:**

1. Keep the temperature within the specified range usage and storage. Excessive temperature and humidity could cause polarization degradation, polarizer peel-off or generate bubbles.
2. For long-term storage over  $40^{\circ}\text{C}$  is required, the relative humidity should be kept below 60%. Avoid direct sunlight.

**Limited Warranty**

YB LCDs and modules are not consumer products, but may be incorporated by YB's customers into consumer products or components thereof, YB does not warrant that its LCDs and components are fit for any such particular purpose.

1. The liability of YB is limited to repair or replacement on the terms set forth below. YB will not be responsible for any subsequent or consequential events or injury or damage to any personnel or user including third party personnel and/or user. Unless otherwise agreed in writing between YB and the customer, YB will only replace or repair any of its

LCD which is found defective electrically or visually when inspected in accordance with YB GENERAL LCD INSPECTION STANDARD. (Copies available on request)

2. No warranty can be granted if any of the precautions state in handling liquid crystal display above has been disregarded. Broken glass, scratches on polarizer mechanical damages as well as defects that are caused accelerated environment tests are excluded from warranty.
3. In returning the LCD/LCM, they must be properly packaged; there should be detailed description of the failures or defect.

**15.DESCRIBE TO THE PART NO:**

